

ERSTD-WM
STANDARD PLATE NO. 3402
RODDING DETAIL
City of Elk River
Howard R. Green Company

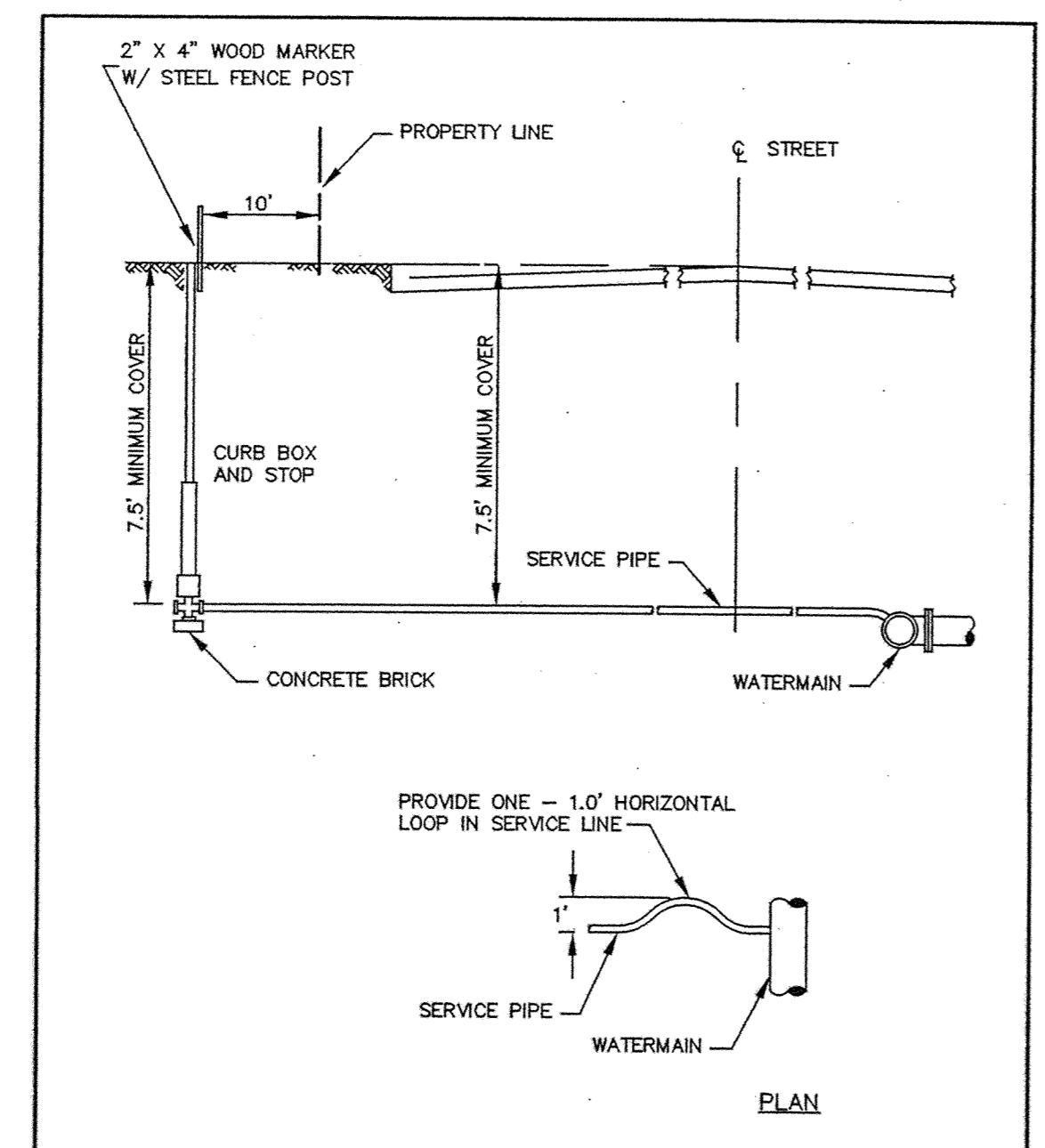

ERSTD-WM
STANDARD PLATE NO. 3403
TYPICAL SERVICE DETAIL
City of Elk River
Howard R. Green Company

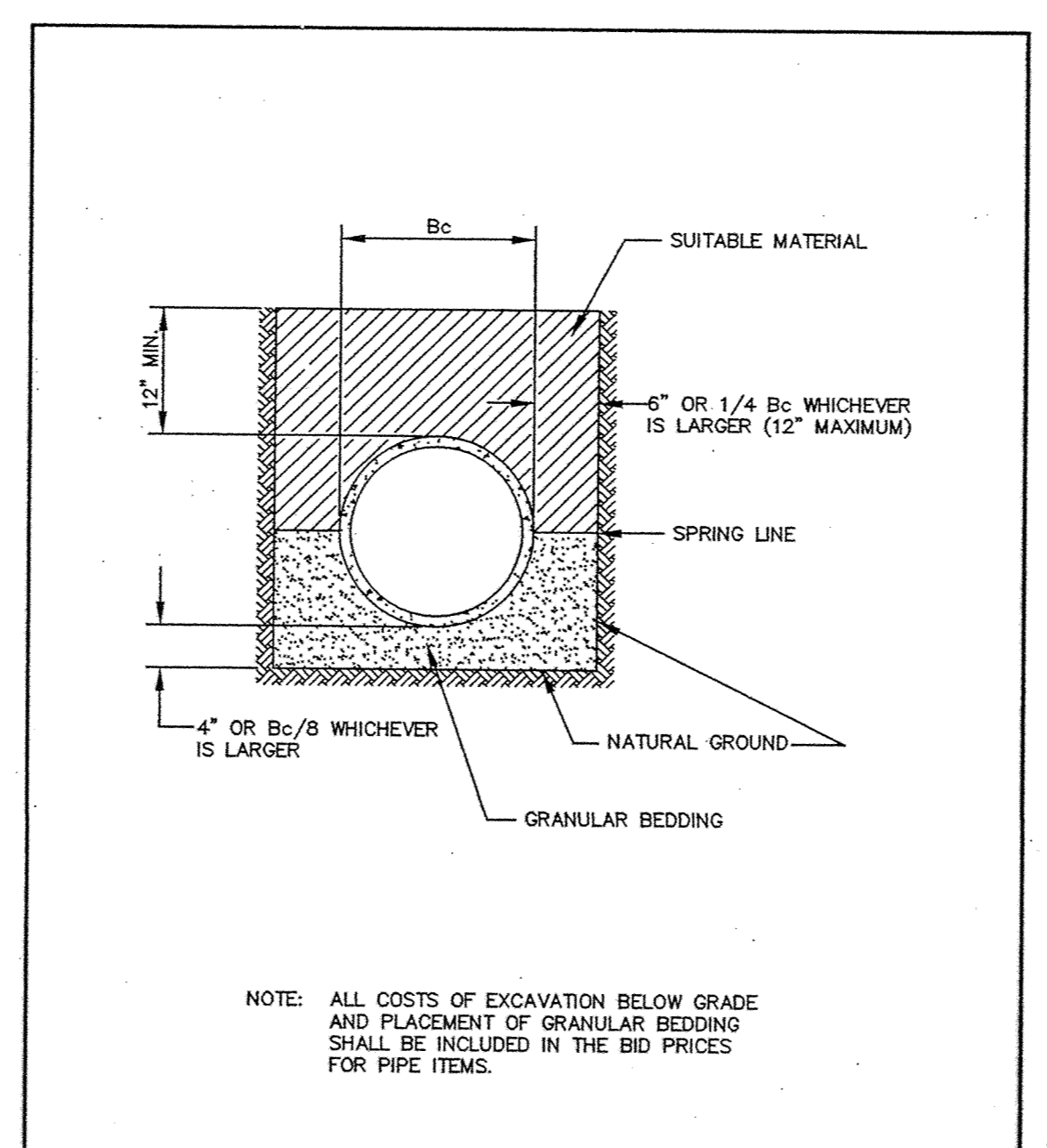

ERSTD-SA
STANDARD PLATE NO. 4006
CLASS B PIPE BEDDING
City of Elk River
Howard R. Green Company

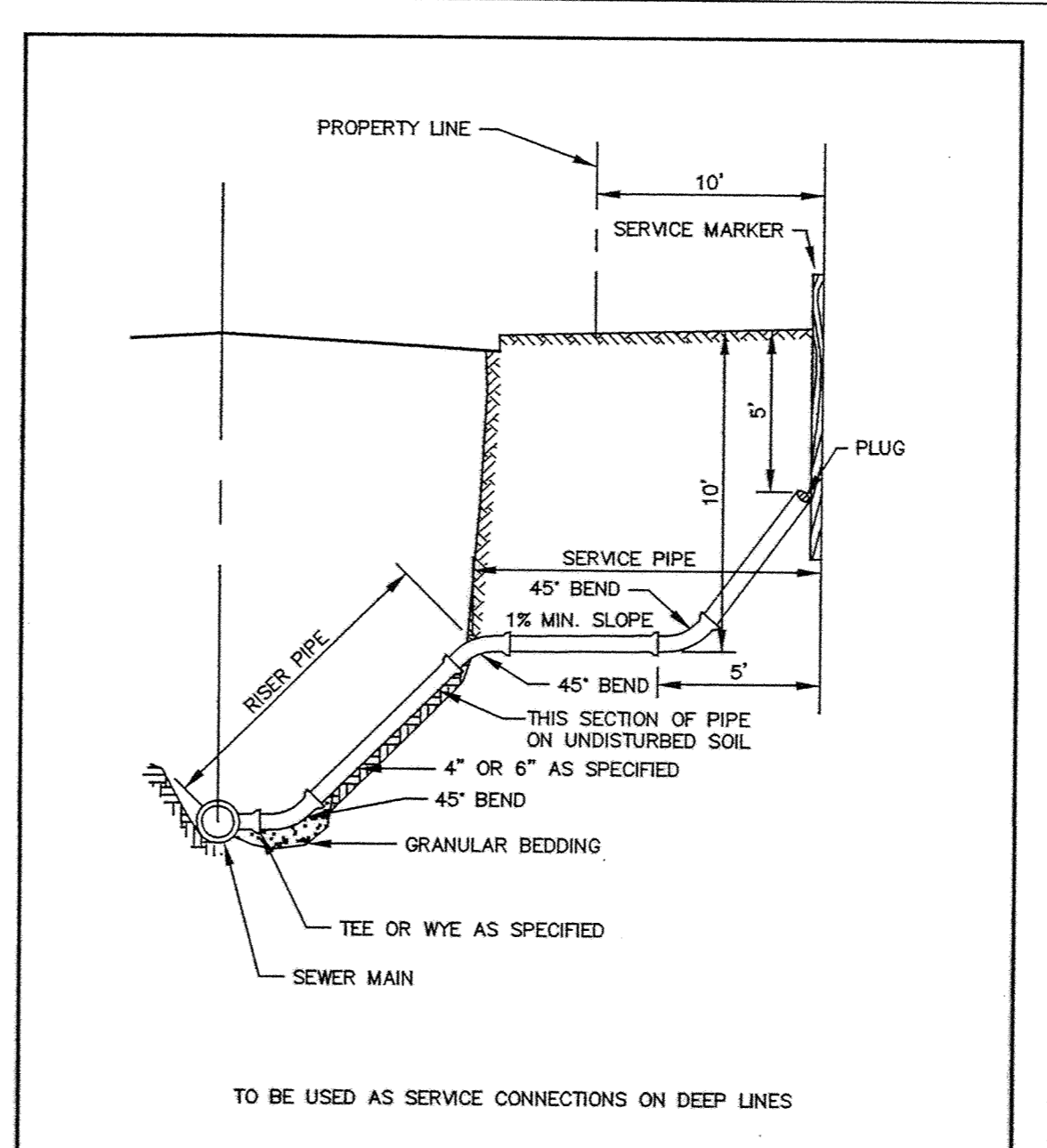

ERSTD-SA
STANDARD PLATE NO. 4008
SERVICE RISER SECTION
City of Elk River
Howard R. Green Company

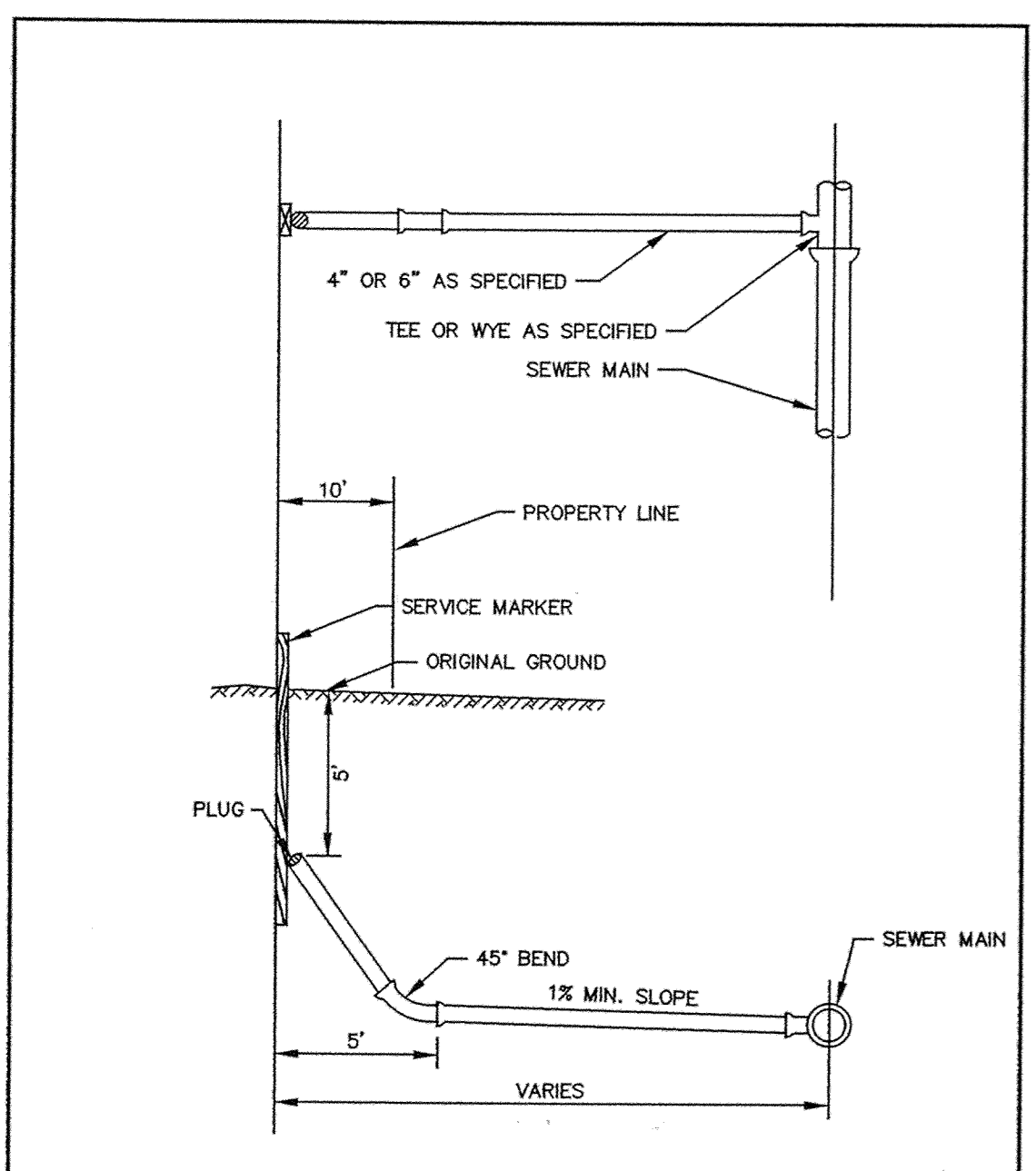

ERSTD-SA
STANDARD PLATE NO. 4007
TYPICAL HOUSE SERVICE
City of Elk River
Howard R. Green Company

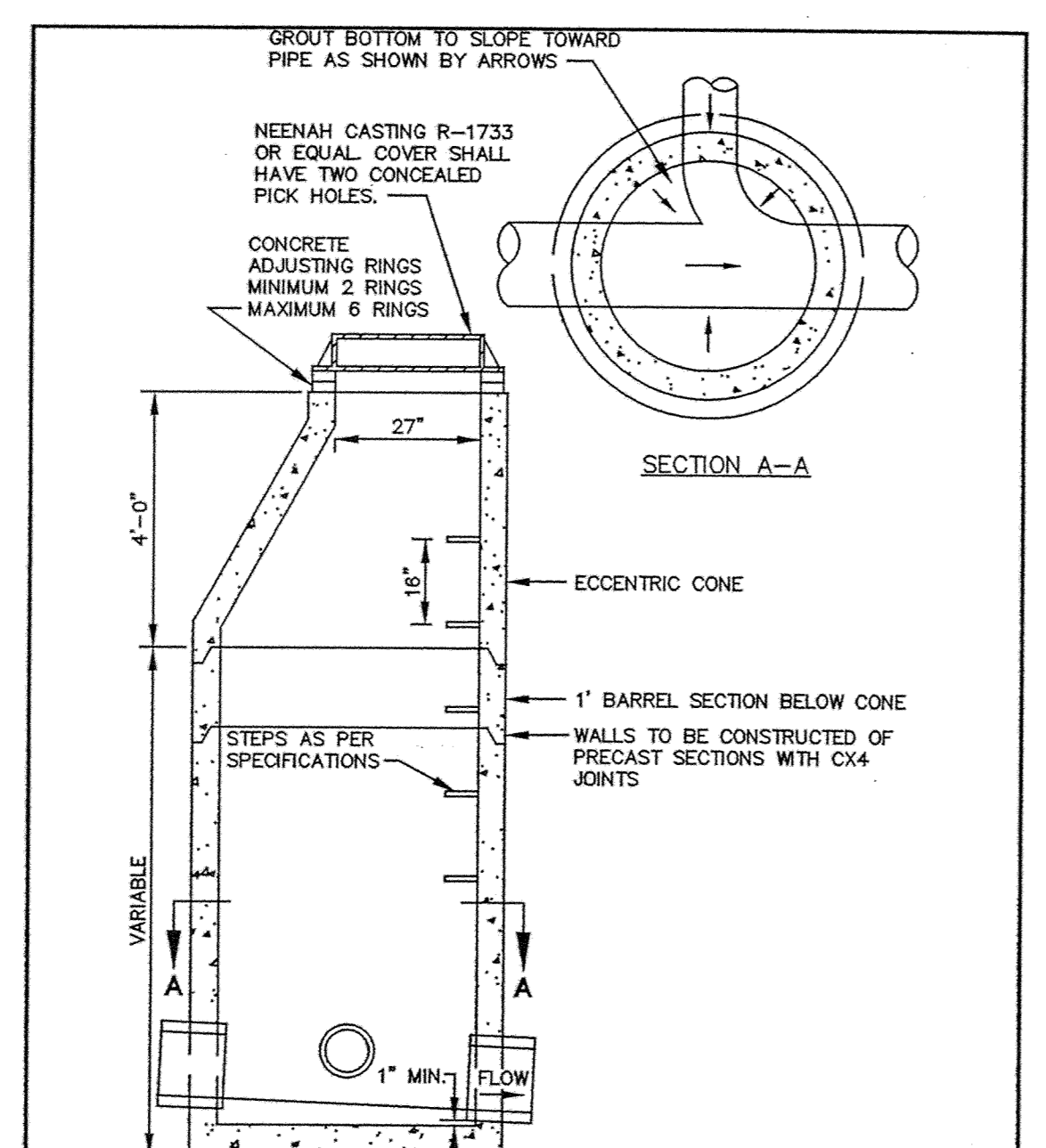

ERSTD-SA
STANDARD PLATE NO. 4000
STANDARD MANHOLE
City of Elk River
Howard R. Green Company

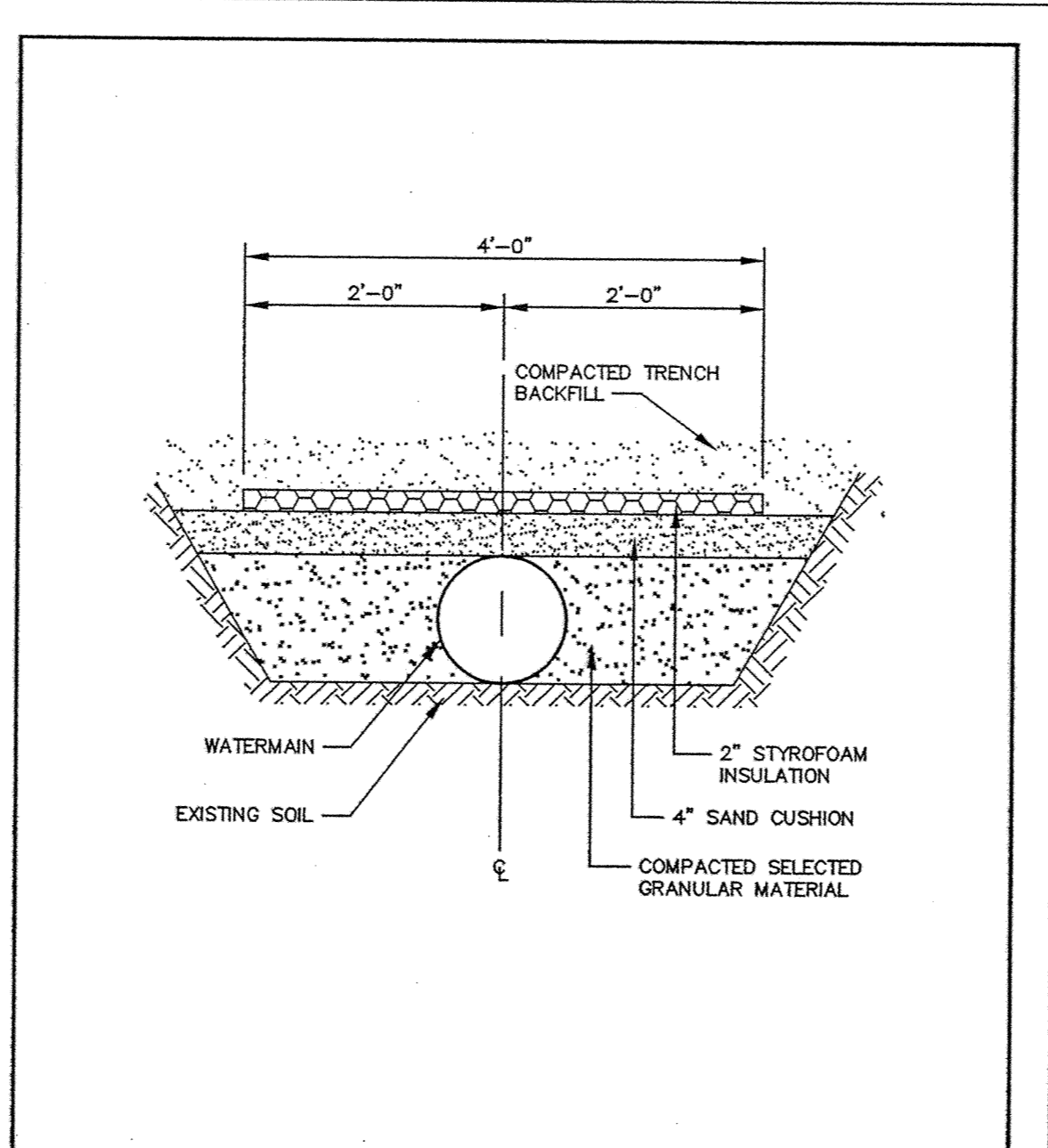

ERSTD-WM
STANDARD PLATE NO. 3407
PIPE INSULATION DETAIL
City of Elk River
Howard R. Green Company

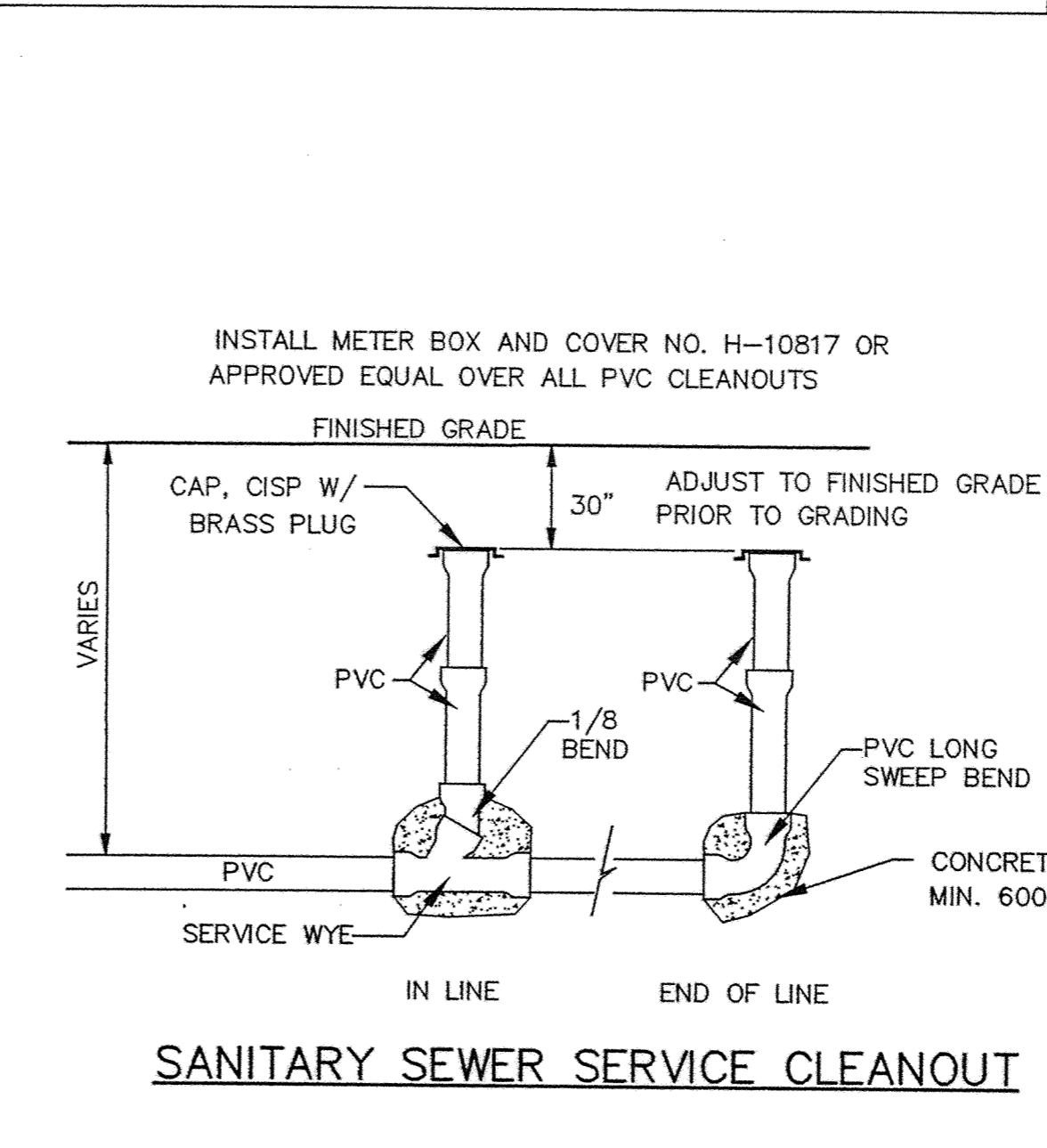

ERSTD-WM
STANDARD PLATE NO. 3407
PIPE INSULATION DETAIL
City of Elk River
Howard R. Green Company